

THULE[®]
SWEDEN

GB Fitting instructions
D Montageanleitung
F Instructions de montage
NL Montage-instructies
I Istruzioni per il montaggio
E Instrucciones de montaje
PT Instruções de Montagem
S Monteringsanvisning
FIN Asennusohje
EST Paigaldusjuhend
LAT Stiprināšanas instrukcija
LIT Pritvirtinimo instrukcijos
PL Instrukcja montażu
RU Инструкции по установке
CZ Návod na montáž

SK Návod na montáž
SLO Navodila za pritrjevanje
HR Uputa za sastavljanje
HU A felszerelés módja
GR Οδηγίες συναρμολόγησης
TR Montaj talimatları
中文 安装说明
日本語 取扱(取付)説明書
한국어 장착 지침
ไทย คำแนะนำการติดตั้ง

Atlantis
200, 600, 780, 900

Follow me...

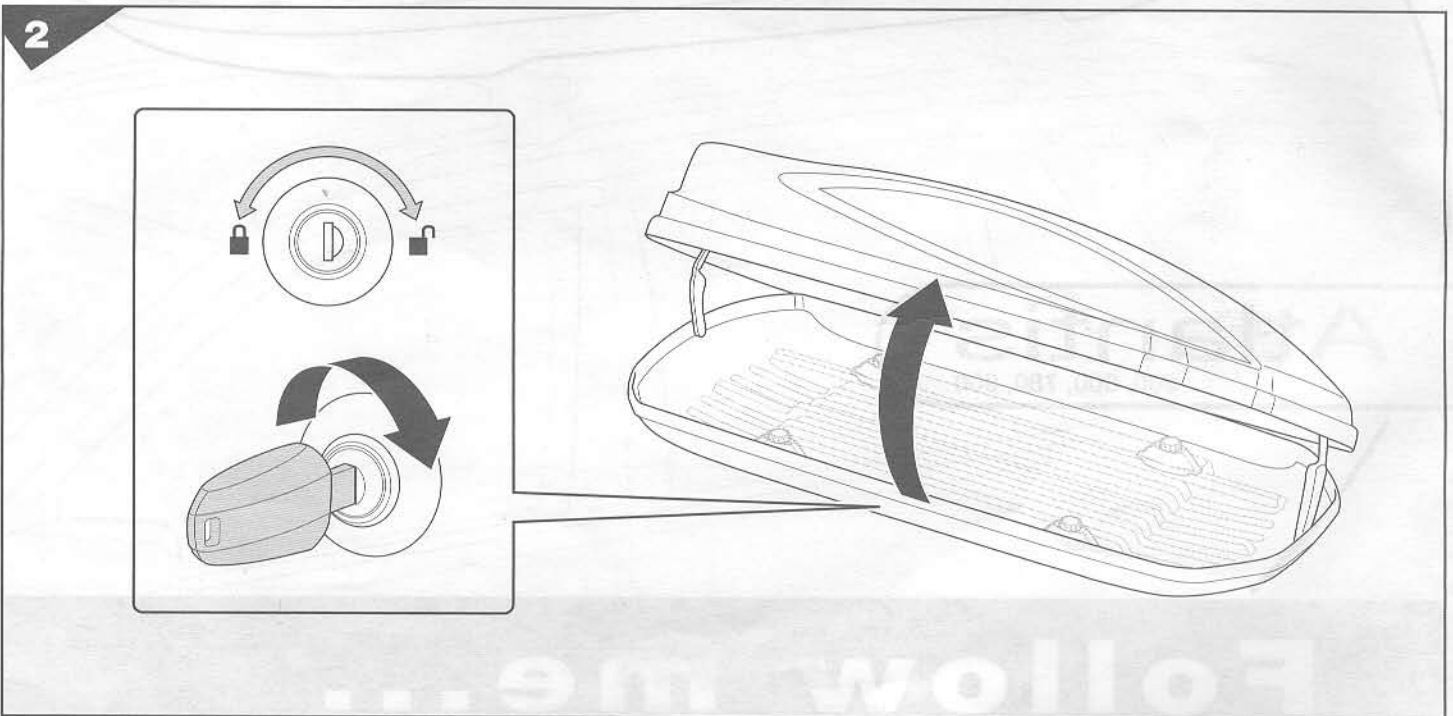
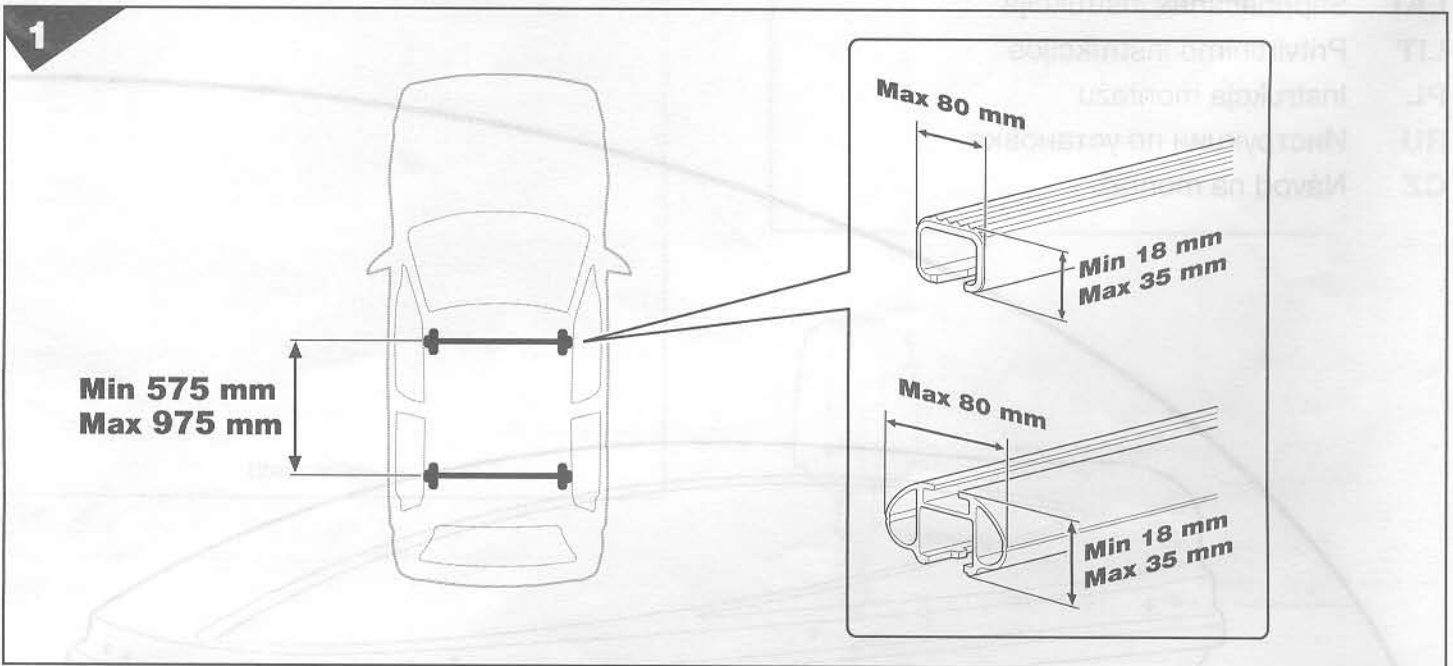
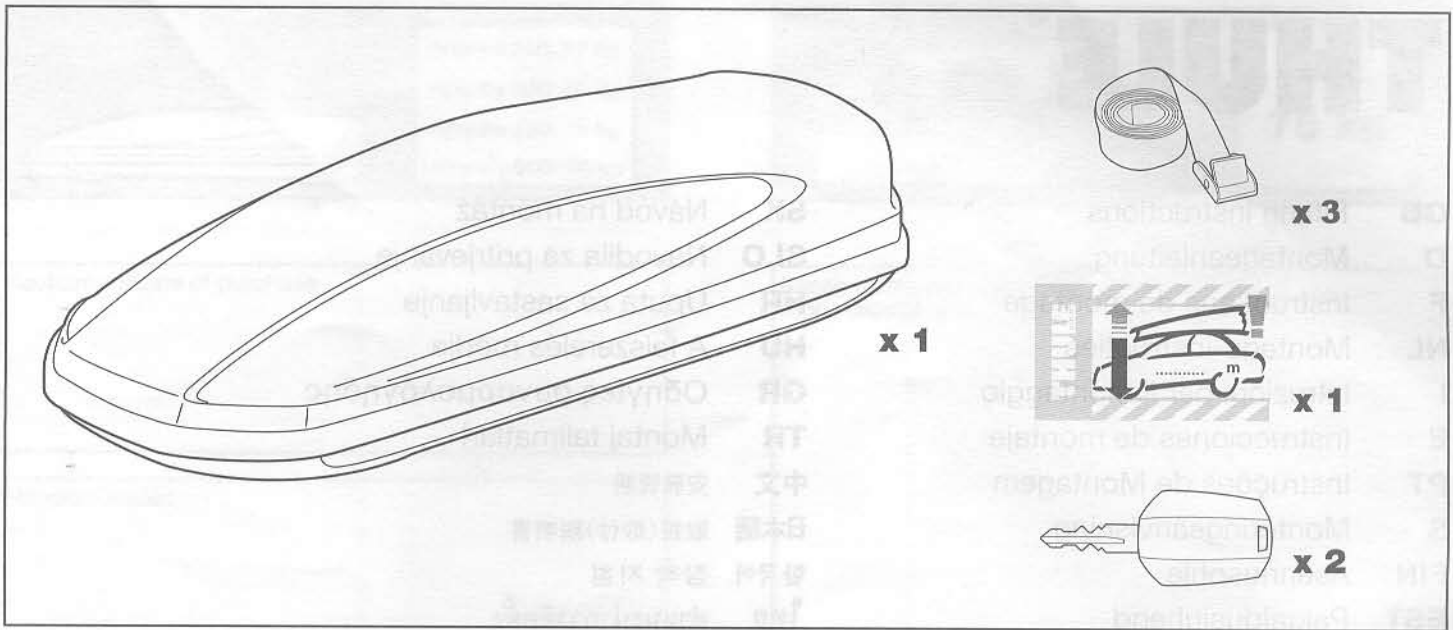

3

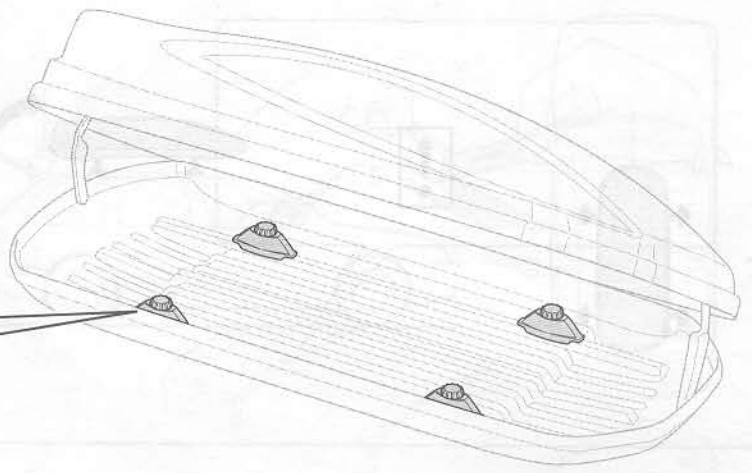
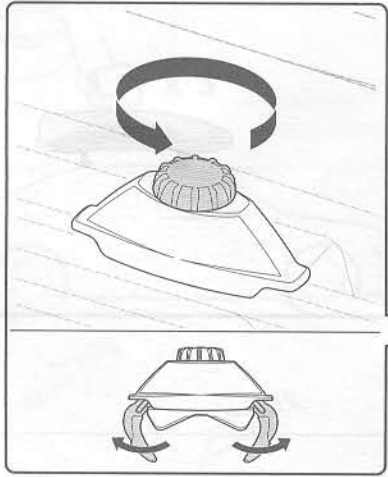

2

4

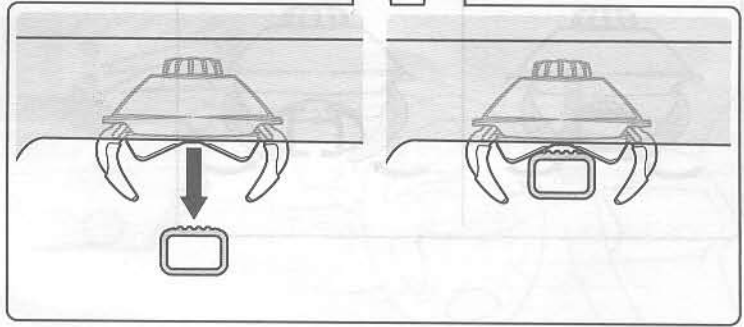
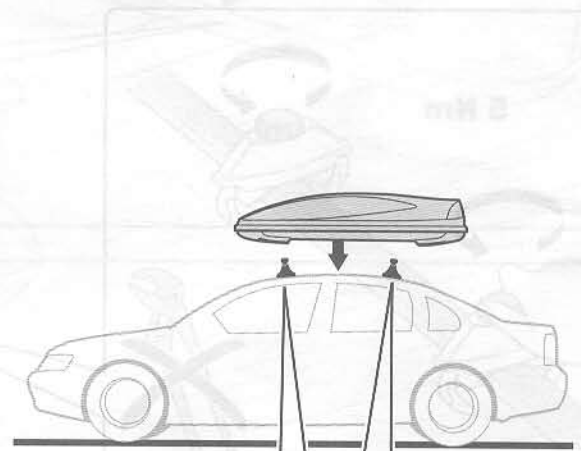
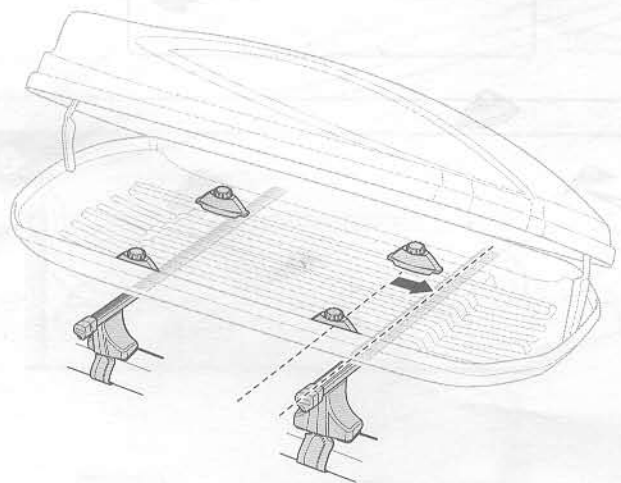
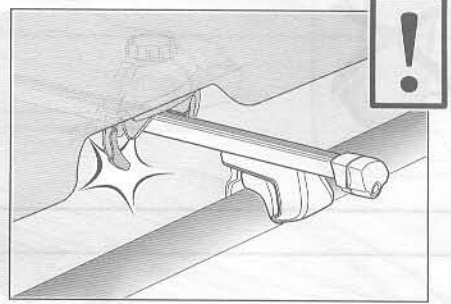
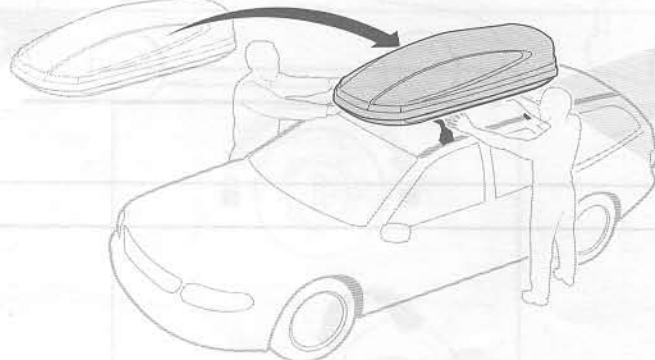

8

5

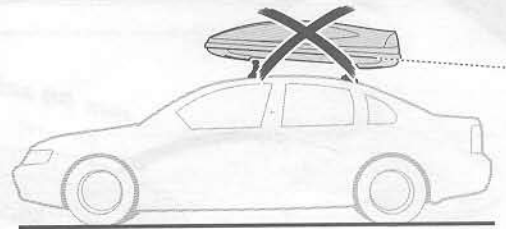
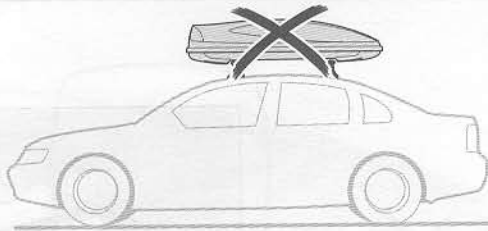
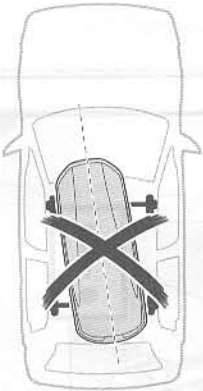
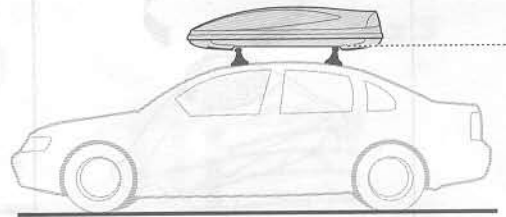
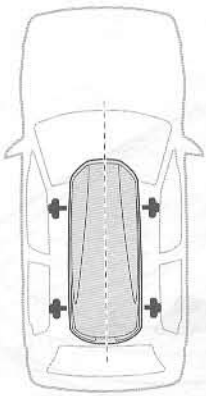

6

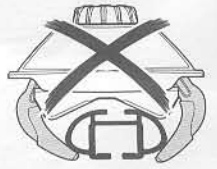
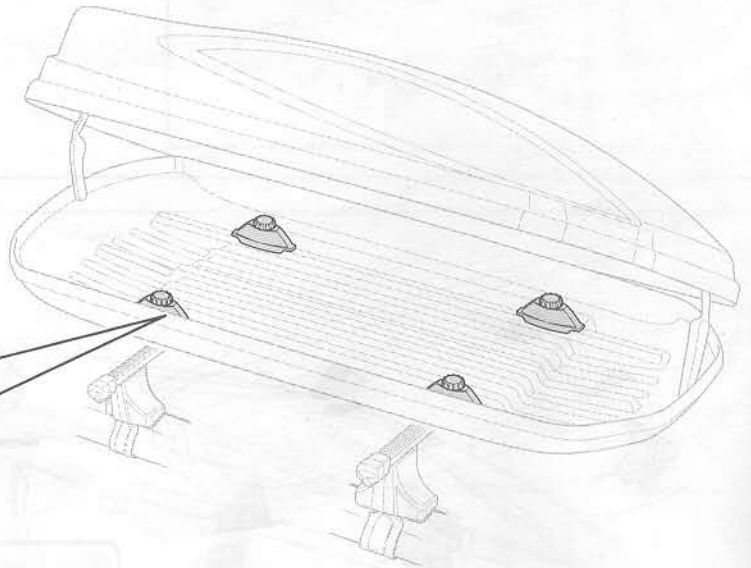
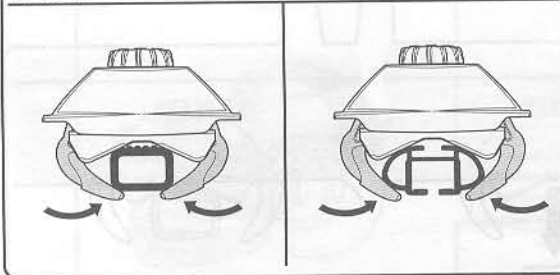
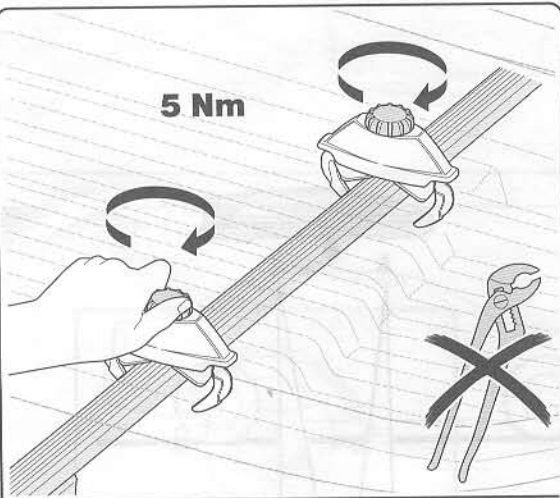

7

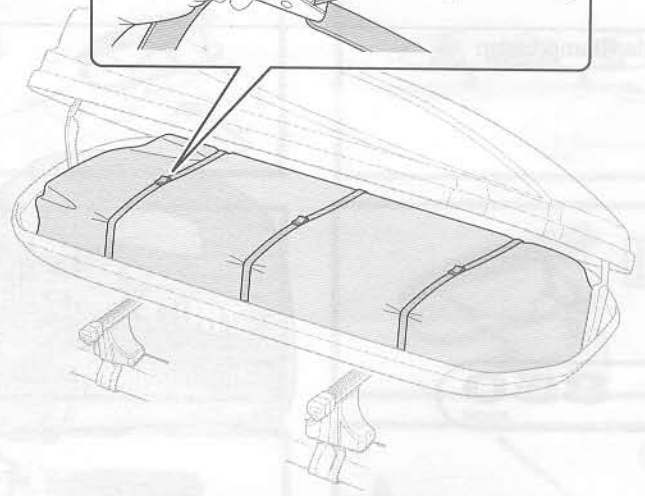
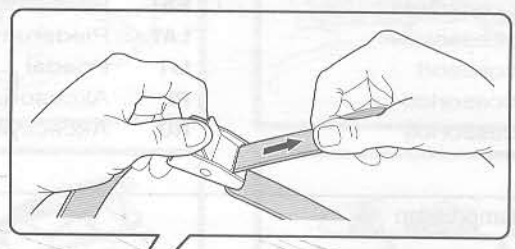
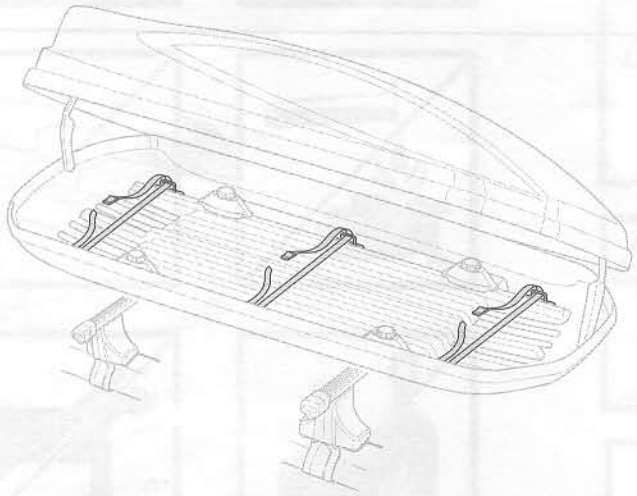
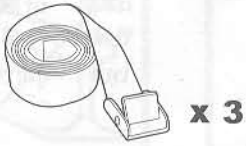

8

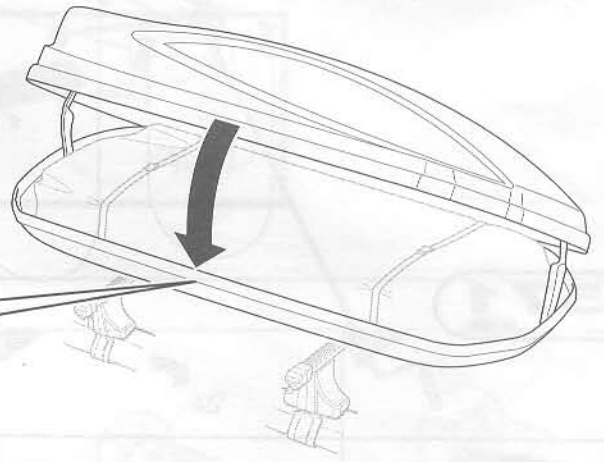
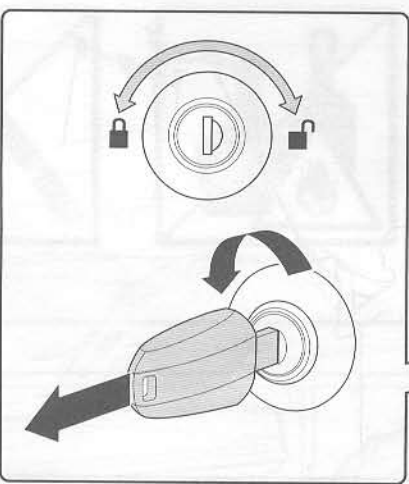

9

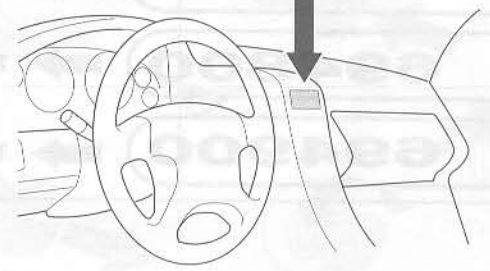
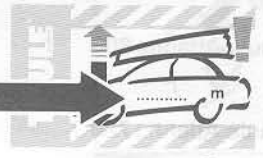
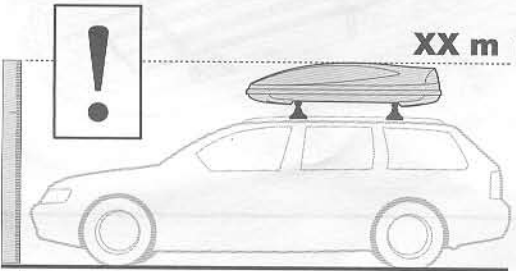
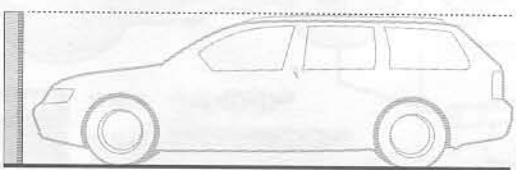

GB Accessories
 D Zubehör
 F Accessoires
 NL Accessoires
 I Accessori
 E Accesorios
 PT Acessórios

S Tillbehör
 FIN Lisävarusteet
 EST Lisavarustus
 LAT Piederumi
 LIT Priedai
 PL Akcesoria
 RU Аксессуары

CZ Doplnky
 SK Príslušenstvo
 SLO Dodatki
 HR Dodaci
 HU Tartozékok
 GR Παρελκόμενα
 TR Aksesuarlar

中文 附件
 日本語 付属品
 한국어 액세서리
 ไทย อุปกรณ์เสริม

Thule Clamp Lamp

850
850000

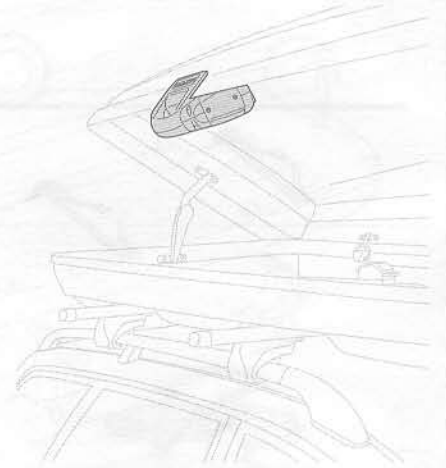

Thule Boxlift

571
571000

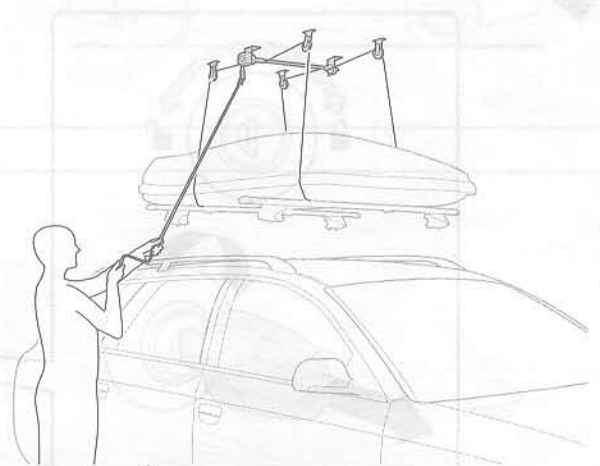
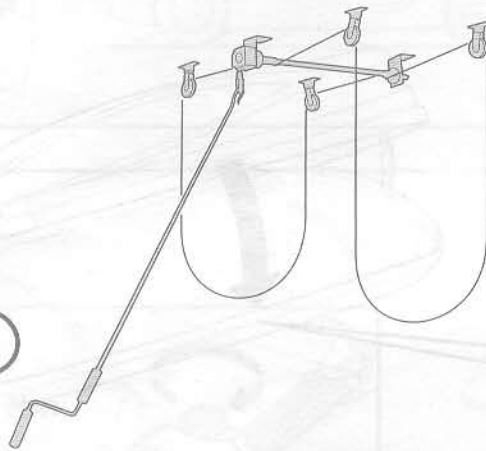

Thule Skicarrier

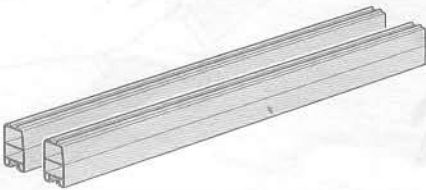

694600



Thule Atlantis 600

694800



Thule Atlantis 780

694900



Thule Atlantis 900

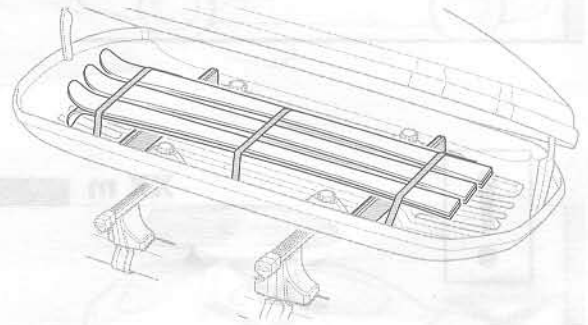

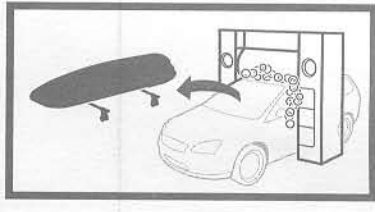
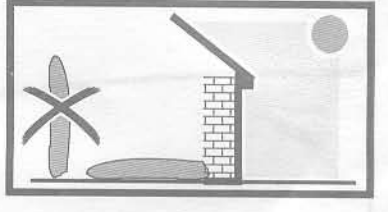
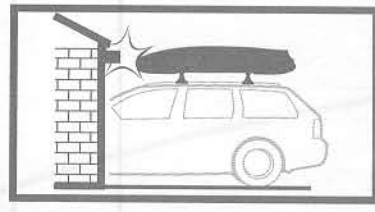
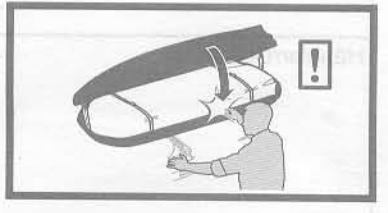
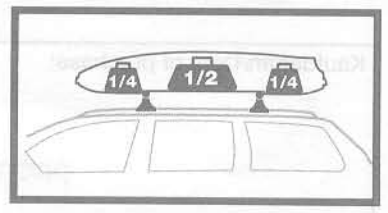
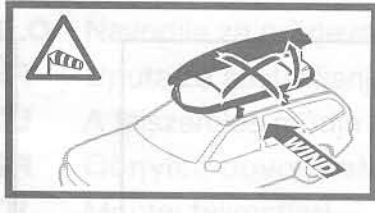
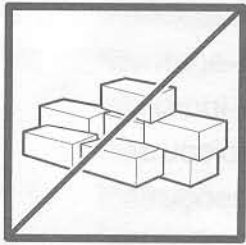
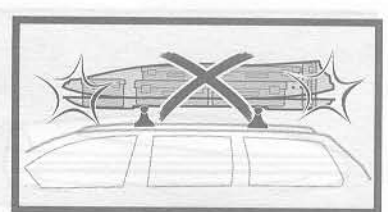
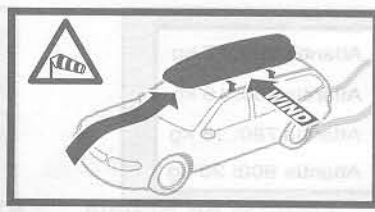

THULE ONE KEY SYSTEM

544	
596	
588	

1. Insert the key into the lock cylinder at a 45-degree angle.
2. Push the key forward to the stop.
3. Turn the key to the right to the stop.
4. Push the key forward to the stop.
5. Turn the key to the left to the stop.
6. Push the key forward to the stop.
7. Turn the key to the right to the stop.
8. Push the key forward to the stop.

Follow

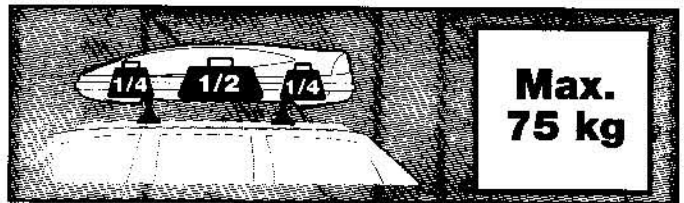
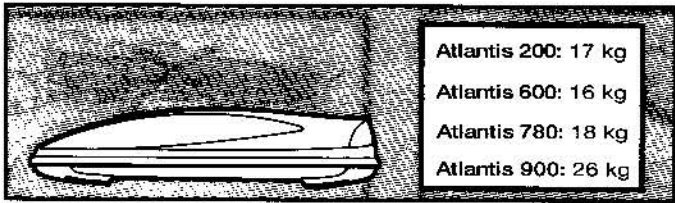

Kaufdatum/Date of purchase:

Kassenzettel hier abheften
Place receipt here

Händler/Dealer:

Stempel/stamp

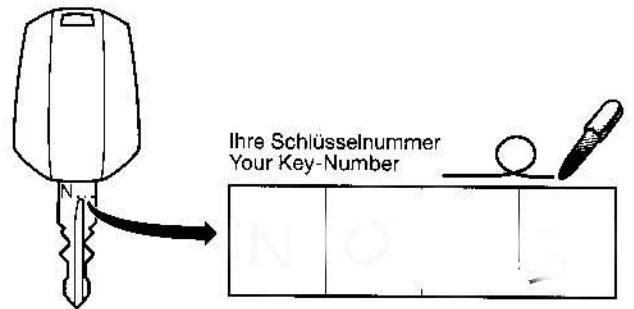

THULE[®]
SWEDEN

Box 69, 330 33 Hillerstorp, SWEDEN
www.thule.com